



# TAB Series

Air Circuit Breaker

## Contents

- 1 **Specification of TAB series**
- 2 **Type designation**
- 3-4 **Digital trip relay of TAB series**
- 5-9 **Function of digital trip relay**
- 10-14 **Dimensions**
- 15-16 **Secondary circuit wiring**
- 17 **Purchase Sheet**



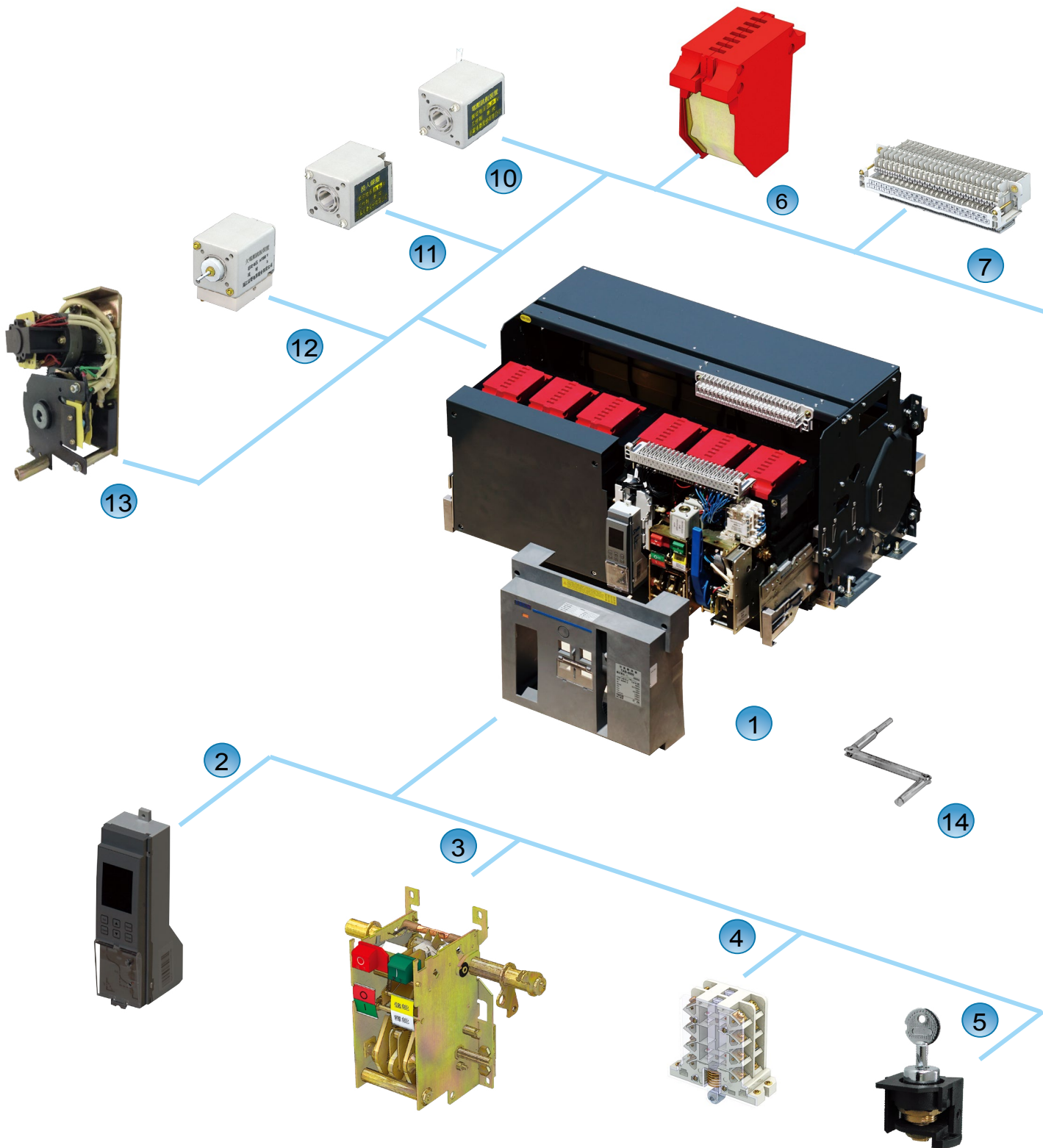

# TAB-2000N ~ 5000 Air Circuit Breaker



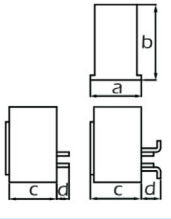

# Specification of TAB series

Type	TAB-2000N (Frame I, Inm=2000A)				TAB-3200 (Frame II, Inm=3200A)				TAB-5000 (Frame III, Inm=5000A)					
Feature														
Installation mode	Fixed		Drawout		Fixed		Drawout		Drawout					
Number of poles	3	4	3	4	3	4	3	4	3	4				
Rated current(In)(A) at ambient temperature 40℃	630 1000 1600 800 1250 2000				2000 2500 3200				4000 5000					
Max. rated operation voltage (Ue) V(50/60Hz)	AC 690V													
Rated insulation voltage (Ui) V(50/60Hz)	AC 1000V													
Rated impulse withstand voltage (Uimp) kV	12													
Rated current of N-pole (A)	—	100%	—	100%	—	100%	—	100%	—	50%				
Rated breaking capacity(kA)														
IEC 60947-2 CNS 14816-2 Icu / Ics	* AC 690V		50 / 40				65 / 52				85 / 75			
	* AC 500V		65 / 42				75 / 60				90 / 70			
	* AC 440V		75 / 48				85 / 68				100 / 80			
	AC380V		85 / 55				100 / 80				130 / 105			
	* AC220V		150 / 95				170 / 136				200 / 160			
Rated short-time withstand capacity Icw Is(kA)	AC 380V		55				65				100			
Overload long time-delay protection	I <sub>R</sub> =(0.4~1.0) I <sub>n</sub> , t <sub>R</sub> = (15~480) s													
Fixed disconnection time(ms)	23~32													
Digital trip relay	Standard type(M)						●				●			
	Multifunctional type(3M)						●				●			
	Communication type(H)						●				●			
Mechanical endurance	10,000													
Connection pattern	Horizontal , Vertical										Horizontal			
Dimensions(mm) 	Horizontal	a	340	435	375	470	400	515	435	550	813	928		
		b	402	402	439	439	402	402	439	439	439	439		
		c	290	290	391	391	290	290	391	391	391	391		
		d	42	42	30.5	30.5	72	72	100	100	103	103		
	Vertical	a	340	435	375	470	400	515	435	550	—	—		
		b	402	402	439	439	402	402	439	439	—	—		
		c	290	290	391	391	290	290	391	391	—	—		
		d	69	69	74	74	99	99	145	145	—	—		
Shunt release (Standard accessory)	AC 110 / 220 / 380V· DC 110 / 220V (Optional)													
Closing electromagnet (Standard accessory)	AC 110 / 220 / 380V· DC 110 / 220V (Optional)													
Auxiliary contact (Standard accessory)	4C													
Motor-driven energy-storage mechanism (Standard accessory)	AC 110 / 220 / 380V· DC 110 / 220V (Optional)													
Optional accessories	Under-voltage release (UVT)		AC 110 / 220 / 380V 、 DC 24 / 110 / 220V (Optional)											
	External leakage zero sequence current transformer		●											
Weight(kg)	Drawout(3poles/4poles)		70 / 84 (1600A) below 79 / 90.5 (2000A)				103 / 130				210 / 233			
	Fixed(3poles/4poles)		44 / 52 (1600A) below 45 / 54 (2000A)				56.5 / 71				—			

Note: 1. \*: Provided for reference (The rated breaking capacities indicated by voltage which marked with \* are for reference.)  
 2. ●: Available , —: Not available  
 3. Users must add PT, if operational voltage to exceed AC380V

# Type designation

TAB □ □ - □ □ □ □ □ □ - □ □ □  
 ① ② ③ ④ ⑤ ⑥ ⑦ ⑧ ⑨ ⑩

①	Type	2Y	2000N
		3Y	3200
		5F	5000
②	Number of poles	3	3P
		4	4P
③	Rated current	06	630A
		08	800A
		10	1000A
		12	1250A
		16	1600A
		20	2000A
		25	2500A
		32	3200A
		40	4000A
		50	5000A
④	Wiring of main circuit	F	Horizontal connection (Fixed)
		D	Horizontal connection (Drawout)
		V	Rotation busbar vertical connection (Drawout)
		L	Rotation busbar horizontal connection (Drawout)
⑤	Intelligent Controller	M1	Short-circuit short delay inverse time+ definite time(M type)
		M2	Definite time short-circuit short delay (M type)
⑥	Controller power	Please see the instruction in Purchase Sheet(page 17), if you need the 3M or H type function.(※ please contact salesman)	
		A	DC 24V (supplied to order)
		B	DC 110V
		C	DC 220V
		E	AC 110V
		F	AC 220V
		G	AC 380V
⑦	Auxiliary contact	1	4 switch contact
		2	3NO 3NC
		3	4NO 4NC
		4	5NO 5NC (M type only)
		5	5 switch contact (5C)
		6	3 switch contact (3C)
⑧	Under voltage release	X	NA
		1	Instantaneous(AC 110V)
		2	Instantaneous(AC 220V)
		3	Instantaneous(AC 380V)
		4	Instantaneous(DC 24V)
		5	Delay 1s(AC 110V)
		6	Delay 1s(AC 220V)
		7	Delay 1s(AC 380V)
		8	Delay 3s(AC 110V)
		9	Delay 3s(AC 220V)
		A	Delay 3s(AC 380V)
		B	Delay 5s(AC 110V)
		C	Delay 5s(AC 220V)
		D	Delay 5s(AC 380V)
⑨	Counter & Keylock	X	n/a
		C	Counter
		I	1 lock 1 key
		J	2 locks 1 key
		K	3 locks 1 key
		L	3 locks 2 keys
		P	C+I
		Q	C+J
		R	C+K
		S	C+L
⑩	Accessories	X	n/a
		1	Position signaling device
		2	Door interlock
		3	External leakage zero sequence current transformer (3P+N)
		4	ZCT 1
		5	ZT-100
		6	1+2
		7	1+3
		8	1+4
		9	1+5
		A	1+2+3
		B	1+2+4
		C	1+2+5
		D	2+3
E	2+4		
F	2+5		

Example :

- TAB2Y-306FM1E1-XXX : TAB-2000N, 3P, Rated current : 630A, Horizontal connection(Fixed), Intelligent controller of M type(Short-circuit short delay inverse time+definite time)/ Shunt release/ Closing electromagnet/Motor-driven energy-storage mechanism(operating voltage : AC110V), Auxiliary contact : Four switch contact
- TAB3Y-425VMC6-9X1 : TAB-3200, 4P, Rated current : 2500A, Rotation busbar vertical connection(Drawout), Intelligent controller of M type(Definite time short-circuit short delay)/ Shunt release/ Closing electromagnet/Motor-driven energy-storage mechanism(operating voltage : DC220V), Auxiliary contact : Three switch contact, Delay 3s(AC 220V), Position signaling device

# Digital trip relay of TAB series

## ▶ Standard type(M type)

### ■ Menu operation explanation of digital trip relay

M type digital trip relay

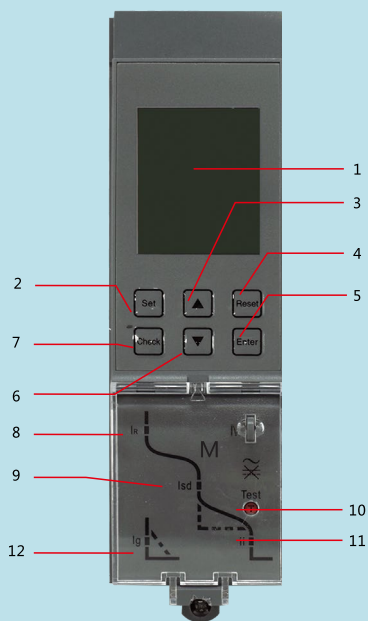

- |                   |  |
|-------------------|--|
| 1. Display window | Display current value, setting value, tripping time and so on.   |
| 2. Set            | Switch to setting menu   |
| 3. ▲(Up)          | Change the marquee or the selected parameter   |
| 4. Reset          | Escape from this grade and return to upper menu or cancel the current selected parameter °                 |
| 5. Enter          | Enter into the next menu directed by the current item, or select current parameter and store modifications |
| 6. ▼(Down)        | Change the marquee or the selected parameter   |
| 7. Check          | Switch to query menu   |
| 8. “Ir” light     | Overload long delay fault indication   |
| 9. “Isd” light    | Short-circuit Short delay indication   |
| 10. “test”        | Trip test button   |
| 11. “Ii” light    | Instantaneous Short-circuit fault indication   |
| 12. “Ig” light    | Asymmetric earthing or neutral line fault indication   |

Note :

Overload long time-delay protection :

$I_R=(0.4\sim 1)I_n$ ,  $t_R=(15\sim 480)s$ ;

Short-circuit short-delay protection :

TAB-2000N :  $I_{sd}=1.5I_R\sim 15I_R$  ;

TAB-3200 :  $I_{sd}=1.5I_R\sim 15I_R$ ,  $I_{sd}$  shouldn't be more than 40kA;

TAB-5000 :  $I_{sd}=1.5I_R\sim 15I_R$ ,  $I_{sd}$  shouldn't be more than 50kA;

$t_{sd} = (0.1\sim 0.4)s$

Instantaneous protection :

TAB-2000N :  $I_i=1.5I_n\sim 50kA$ ;

TAB-3200 :  $I_i=1.5I_n\sim 65kA$ ;

TAB-5000 :  $I_i=1.5I_n\sim 75kA$ ;

Earthing protection :

TAB-2000N :  $I_g=(0.2\sim 0.8)I_n$ ,  $I_g$  shouldn't be more than 1200A;

TAB-3200 :  $I_g=(500\sim 1200A)$ ;

TAB-5000 :  $I_g=(500\sim 1200A)$ ;

$t_g = (0.1\sim 0.4)s$





## Multifunction type (3M type) and communication type (H type)

### Menu operation explanation of digital trip relay

3M/H Type digital trip relay

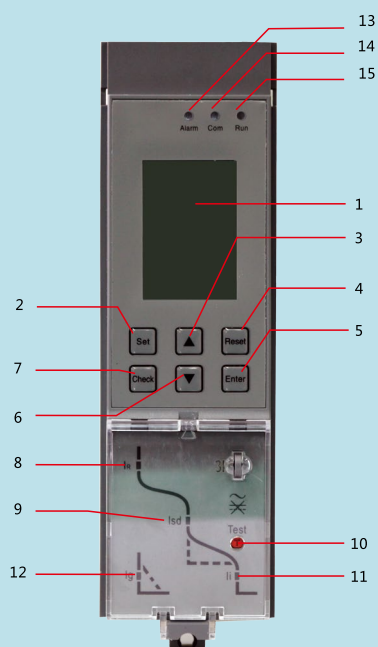

- |                         |  |
|-------------------------|--|
| 1. Display window       | Display current value, setting value, tripping time and so on.   |
| 2. Set                  | Switch to setting menu   |
| 3. ▲(Up)                | Change the marquee or the selected parameter   |
| 4. Reset                | Escape from this grade and return to upper menu or cancel the current selected parameter                   |
| 5. Enter                | Enter into the next menu directed by the current item, or select current parameter and store modifications |
| 6. ▼(Down)              | Change the marquee or the selected parameter   |
| 7. Check                | Switch to query menu   |
| 8. “Ir ” light          | Overload long delay fault indication   |
| 9. “Isd ” light         | Short-circuit Short delay indication   |
| 10. “test”              | Trip test button   |
| 11. “Ii” light          | Instantaneous Short-circuit fault indication   |
| 12. “Ig” light          | Asymmetric earthing or neutral line fault indication   |
| 13. Alarm light         |  |
| 14. Communication light |  |
| 15. Run light           |  |

Note : Follow the Modbus or Profibus+Dp (optional module) communication protocol.

Overload long time-delay protection :  
 $I_R=(0.4\sim 1)I_n$ ,  $t_R=(15\sim 480)s$ ;

Short-circuit short-delay protection :  
TAB-2000N :  $I_{sd}=1.5I_R\sim 15I_R$  ;  
TAB-3200 :  $I_{sd}=1.5I_R\sim 15I_R$ ,  $I_{sd}$  shouldn't be more than 40KA;  
TAB-5000 :  $I_{sd}=1.5I_R\sim 15I_R$ ,  $I_{sd}$  shouldn't be more than 50KA;  
 $t_{sd} = (0.1\sim 0.4)s$

Instantaneous protection :  
TAB-2000N :  $I_i=1.5I_n\sim 50kA$ ;  
TAB-3200 :  $I_i=1.5I_n\sim 65kA$ ;  
TAB-5000 :  $I_i=1.5I_n\sim 75kA$ ;

Earthing protection :  
TAB-2000N :  $I_g=(0.2\sim 0.8)I_n$ ,  $I_g$  shouldn't be more than 1200A;  
TAB-3200 :  $I_g=(500\sim 1200A)$ ;  
TAB-5000 :  $I_g=(500\sim 1200A)$ ;  
 $t_g = (0.1\sim 0.4)s$

# Function of digital trip relay

## ▶ Function configuration

No.	Function configuration	Type		
		M	3M	H
1	Current display function	●	●	●
2	Overload long time delay protection(inverse)	●	●	●
3	Short circuit short time delay protection(inverse and definite)	●	●	●
4	Short circuit instantaneous protection	●	●	●
5	Single-phase earthing fault protection	●	●	●
6	Current imbalance protection caused by phase failure	○	●	●
7	Parameter setting function	●	●	●
8	Test(simulate trip) function	●	●	●
9	Inquiry function	●	●	●
10	Self-diagnose function	●	●	●
11	Communication function	—	—	●
12	Contact abrasion extent record	●	●	●
13	Operating times record	●	●	●
14	Clock function	—	●	●
15	Alarm record	●	●	●
16	Position(making or breaking)change record	—	●	●
17	The history current peak value record	—	●	●
18A	MCR(Making current release)	●	●	●
18B	HSISC(High-setting instantaneous short circuit)	●	●	●
19	Current leakage protection(inverse and definite)	—	○	○
20	Neutral(N phase)protection	●	●	●
21	overload pre-alarm	●	●	●
22	Load monitor function(Modes 1 and Modes 2)	—	● (Note 1)	●
23	Voltage measurement display function	—	—	●
24	Frequency measurement display function	—	—	●
25	Voltage imbalance measurement display function	—	—	●
26	Power measurement display function	—	—	●
27	Power factor measurement display function	—	—	●
28	Electrical energy measurement display function	—	—	●
29	Fault clock function	—	—	●
30	History data record function	●	●	●
31	Phase sequence checking	—	●	●
32	Average value in a certain period of time measurement function(current and power)	—	—	●
33	Humorous-wave measurement	—	—	●
34	Over-voltage protection	—	—	●
35	Under-voltage protection	—	—	●
36	Voltage imbalance protection	—	—	●
37	Over-frequency protection	—	—	●
38	Under-frequency protection	—	—	●
39	Phase sequence protection	—	—	●
40	Inverse power protecion	—	—	●
41	Thermal recall function	●	●	●
42	ZSI(zone selective interlocking)	—	○	○

● : stands for definite setting   ○ : stands for optional setting   — : stands for no function

Note 1 : 3M type product can choose control shunt load function.

## ▶ Standard type(M type)



Overload long time-delay protection :

$$I_R = (0.4 \sim 1) I_n, t_R = (15 \sim 480) s;$$

Short-circuit short-delay protection :

$$TAB-2000N : I_{sd} = 1.5 I_R \sim 15 I_R ;$$

TAB-3200 :  $I_{sd} = 1.5 I_R \sim 15 I_R$ ,  $I_{sd}$  shouldn't be more than 40kA;

TAB-5000 :  $I_{sd} = 1.5 I_R \sim 15 I_R$ ,  $I_{sd}$  shouldn't be more than 50kA;

$$t_{sd} = (0.1 \sim 0.4) s$$

Instantaneous protection :

$$TAB-2000N : I_i = 1.5 I_n \sim 50 kA;$$

$$TAB-3200 : I_i = 1.5 I_n \sim 65 kA;$$

$$TAB-5000 : I_i = 1.5 I_n \sim 75 kA;$$

Earthing protection :

$$TAB-2000N : I_g = (0.2 \sim 0.8) I_n, I_g \text{ shouldn't be more than } 1200A;$$

$$TAB-3200 : I_g = (500 \sim 1200A);$$

$$TAB-5000 : I_g = (500 \sim 1200A);$$

$$t_g = (0.1 \sim 0.4) s$$

## ▶ Multifunctional type(3M type) and Communication type(H type)



Overload long time-delay protection :

$$I_R = (0.4 \sim 1) I_n, t_R = (15 \sim 480) s;$$

Short-circuit short-delay protection :

$$TAB-2000N : I_{sd} = 1.5 I_R \sim 15 I_R ;$$

TAB-3200 :  $I_{sd} = 1.5 I_R \sim 15 I_R$ ,  $I_{sd}$  shouldn't be more than 40kA;

TAB-5000 :  $I_{sd} = 1.5 I_R \sim 15 I_R$ ,  $I_{sd}$  shouldn't be more than 50kA;

$$t_{sd} = (0.1 \sim 0.4) s$$

Instantaneous protection :

$$TAB-2000N : I_i = 1.5 I_n \sim 50 kA;$$

$$TAB-3200 : I_i = 1.5 I_n \sim 65 kA;$$

$$TAB-5000 : I_i = 1.5 I_n \sim 75 kA;$$

Earthing protection :

$$TAB-2000N : I_g = (0.2 \sim 0.8) I_n, I_g \text{ shouldn't be more than } 1200A;$$

$$TAB-3200 : I_g = (500 \sim 1200A);$$

$$TAB-5000 : I_g = (500 \sim 1200A);$$

$$t_g = (0.1 \sim 0.4) s$$

Note: Follow Modbus or Profibus+Dp (optional module) communication protocol.

## Specifications of characteristics

### Over-current protection characteristic curve

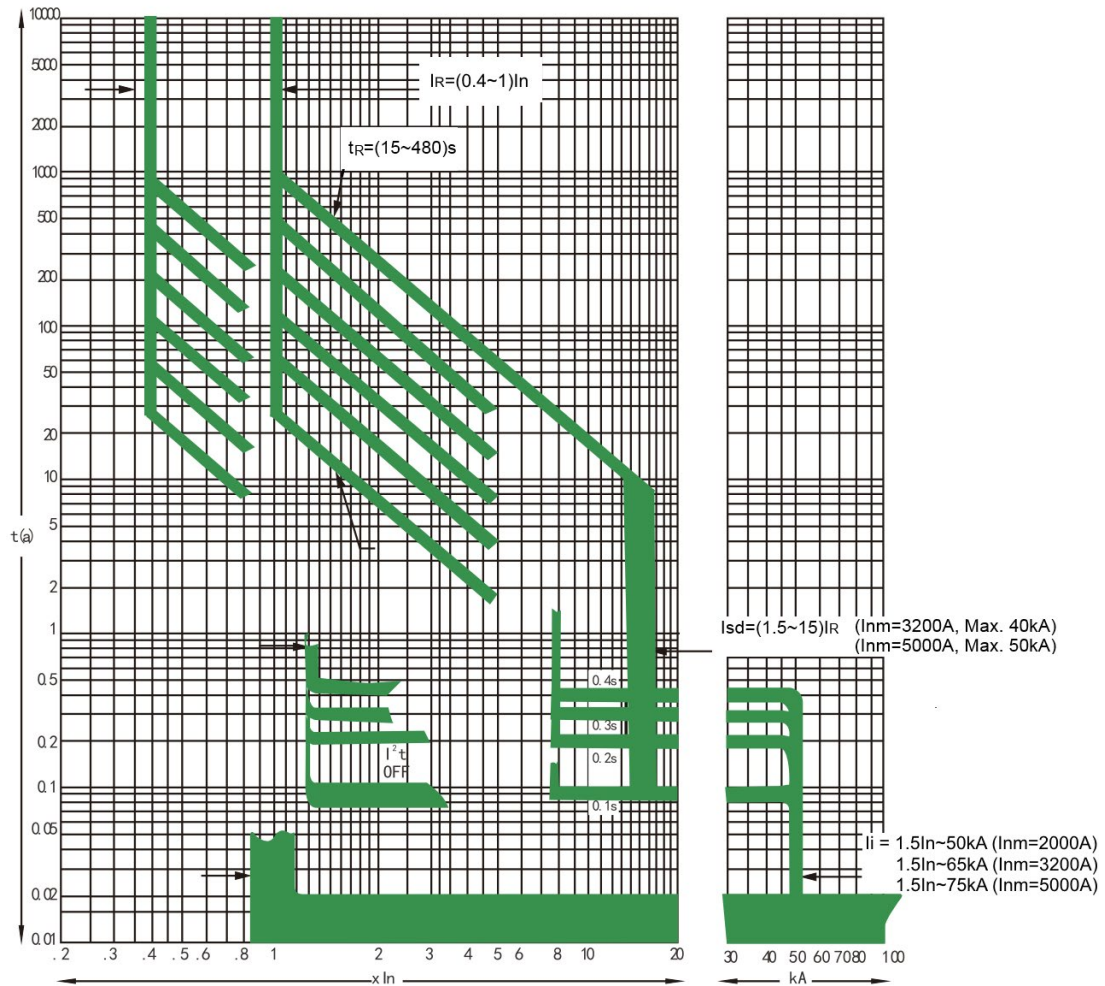

### Overload long time -delay protection :

Current Ratings Range ( $I_R$ )	tolerance	Current	Action time(s)	Time tolerance
(0.4~1) $I_n$ (OFF can turn off this feature)	$\pm 10\%$	$\leq 1.05 I_R$	>2h Non-trip	
		$> 1.30 I_R$	<2h trip	
		$1.5 I_R$	15 30 60 120 240 480	$\pm 10\%$
		$2.0 I_R$	8.4 16.9 33.7 67.5 135 270	$\pm 10\%$

◆ Short-circuit short-delay protection :

Short-circuit short delay protection has two protection modes. One is inverse time and definite time protection.  $I^2Tsd=(8I_R)^2tsd$  works when current is low. In this formula, I is actual current, Tsd is actual trip time, tsd is set trip delay time.

When I is over inverse time set value but below  $8I_R$ , controller will operate according to over-current protection characteristic curve. When I is over both of inverse time set value and  $8I_R$ , controller will operate according to definite time protection. The other is definite time protection and set time is 0.1s, 0.2s, 0.3s, and 0.4s.

When I is over  $I_{sd}$  but below  $I_i$ , controller will operate according to definite time protection.

Current Ratings Range( $I_{sd}$ )	tolerance	Current	Action time(s)	Time tolerance
$(1.5\sim 15)I_R$ (OFF can turn off this feature)	$\pm 10\%$	$\leq 0.9I_{sd}$	In the 2tsd Non-trip	
		$>1.1 I_{sd}$	In the 2tsd Delayed-trip	
		tsd	0.1    0.2    0.3    0.4	$\pm 15\%$
		Returnable time	0.06   0.14   0.25   0.33	$\pm 15\%$

Note: a. When the intelligent controller is Frame II ( $I_{nm}=3200A$ ),  $I_{sd}$  shouldn't be more than 40kA.

b. When the intelligent controller is Frame III ( $I_{nm}=5000$ ),  $I_{sd}$  shouldn't be more than 50kA.

c. When tsd is 0.1s or 0.2s, time permissible error is  $\pm 0.040s$ .

◆ Instantaneous protection :

Instantaneous protection trip time should be less than 100ms.

Operating characteristics :

Current Ratings Range( $I_i$ )	tolerance	Current	Time tolerance
$(1.5\sim 20)I_n$ (OFF can turn off this feature)	$\pm 15\%$	$\leq 0.85 I_i$	in the 0.2s Non-trip
		$>1.15 I_i$	in the 0.2s trip

◆ Earthing protection :

Earthing protection has definite time characteristic. Fault delay time is shown below.

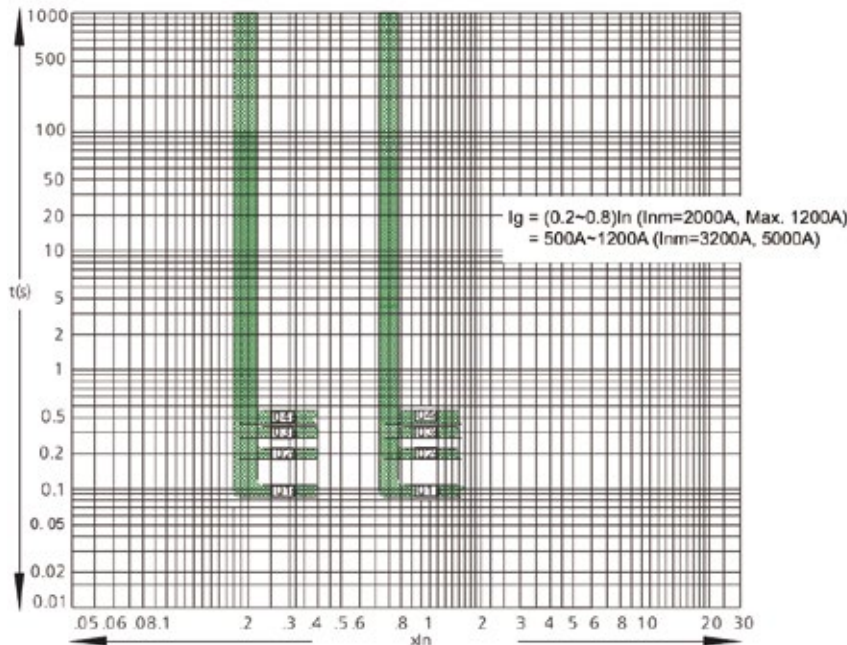

## ◆ Operating characteristics of single-phase earthing protection

Current Ratings Range(Ig)	tolerance	Current	Action time(s)	Time tolerance
Inm=2000 (0.2~0.8)In Inm=3200, 5000 (500~1200)A (OFF can turn off this feature)	±10%	$\leq 0.9 I_g$	In the 2tg Non-tripping	
		$> 1.1 I_g$	In the $tg \pm 0.032s$ or $tg(1 \pm 25\%)$ Tripping	
		tg	0.1    0.2    0.3    0.4	±15%

Note : a. When tg is 0.1s or 0.2s, time permissible error is  $\pm 0.040s$ ;

b. When Inm is 2000A, Ig shouldn't be more than 1200A.

c. When Inm is 3200A or 5000A, Ig should be between 500A and 1200A.

Bolted single-phase protection is usually used in neutral-point solid ground system. Controller has two different protection modes, being vector sum mode and external transformer mode.

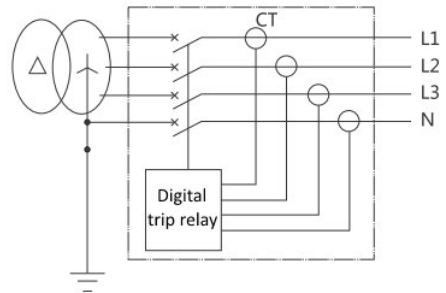
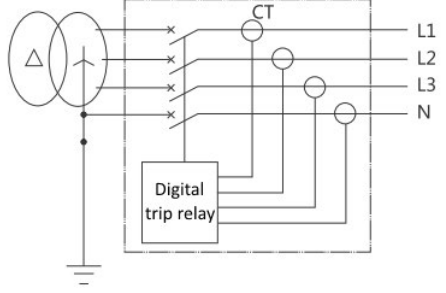
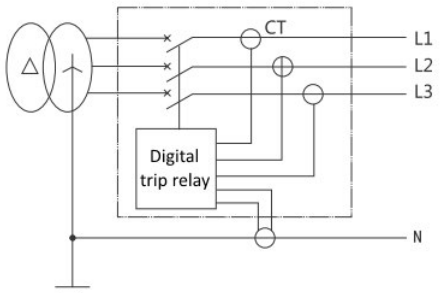
<p>In three-phase three-wire system using 3-pole breaker without external transformer, earthing fault signal comes from three- phase current vector sum. Operating characteristic is definite time protection.</p>	
<p>In three-phase four-wire system using 4-pole breaker without external transformer, earthing fault signal comes from three- phase current and N-Pole current vector sum. Operating characteristic is definite time protection.</p>	
<p>In three-phase four-wire system using 3-pole breaker with external N-pole transformer, earthing fault signal comes from three- phase and N-Pole current vector sum. Operating characteristic is definite time protection.</p> <p>Note:</p> <ol style="list-style-type: none"> <li>① External N-pole transformer (connected to 25#, 26# terminal for TAB-2000N-5000) is a special product. Default lead wire is 2 meters long.</li> <li>② Earthing protection in 3PT mode can only be used in balance load. It should be turned off or set value above allowable unbalance current when the load is unbalance or the controller may operate.</li> <li>③ The distance between external transformer and breaker should be less than 5m in (3P+N)T mode. When lead wire of external transformer needs to be longer than 2 meters, special equirement should be noted when ordering.</li> </ol>	

# Dimensions and connection

Unit : mm

## TAB-2000N Fixed-type

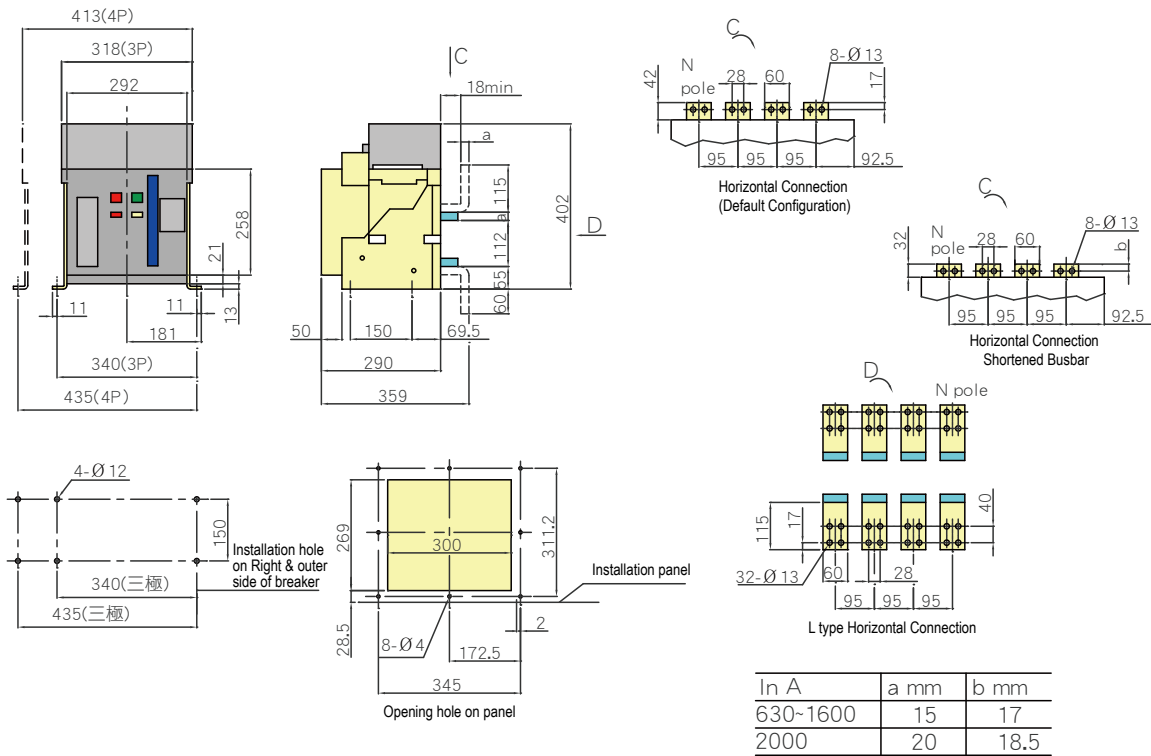

## TAB-2000N Drawout-type

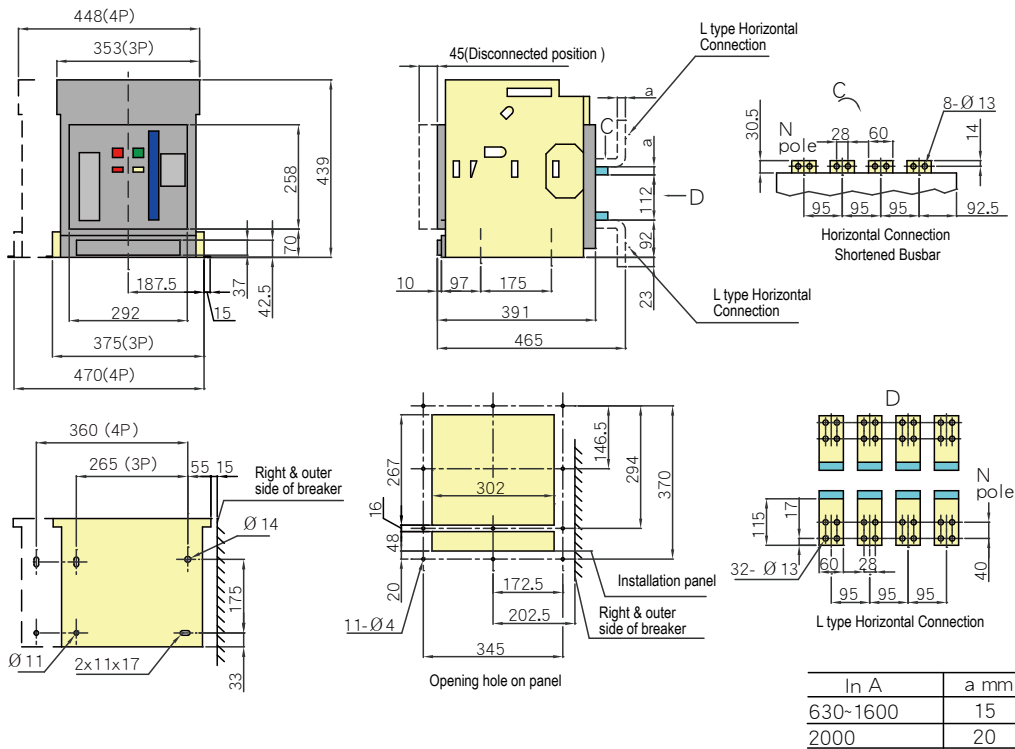

**TAB-2000N Drawout-type, Horizontal, rear connection**

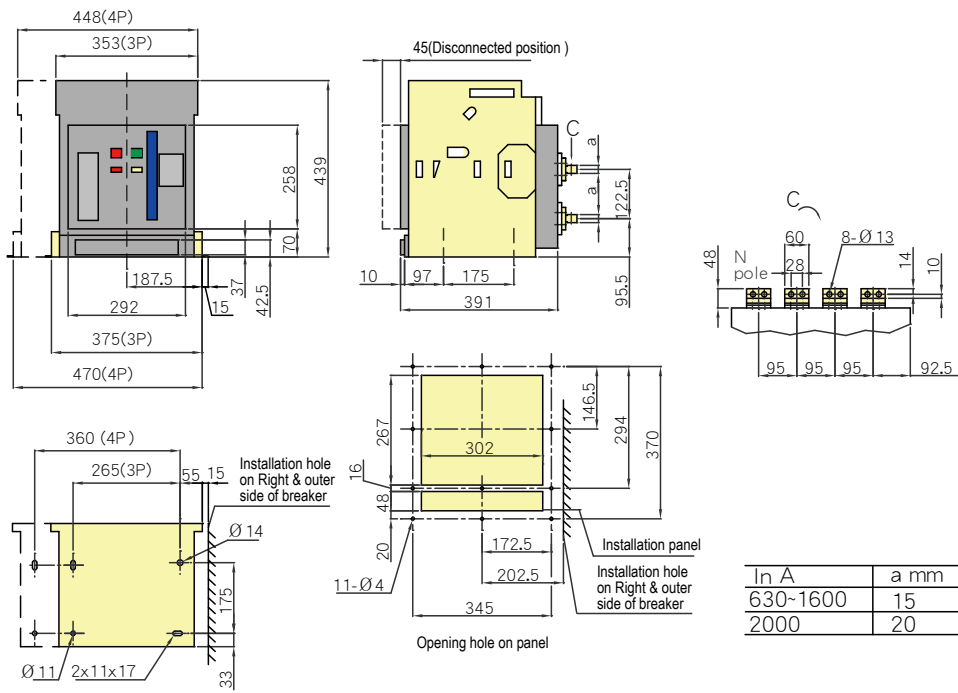

Note : The busbar must rotate 90 degrees if user would become the vertical connection.

**TAB-2000N Drawout-type, Vertical, rear connection**

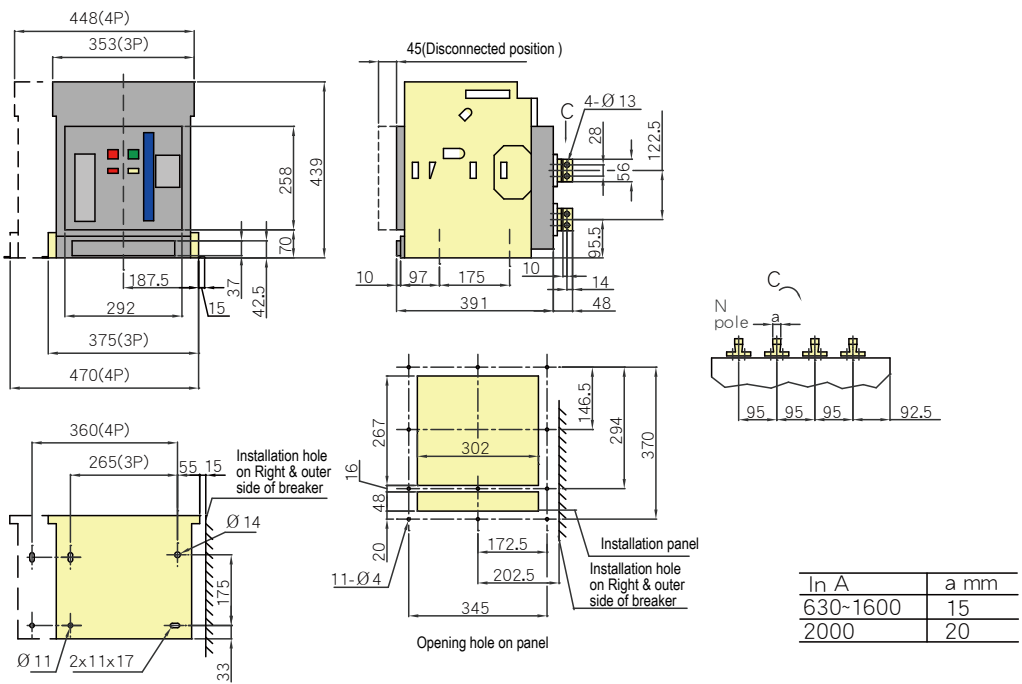

Note : The busbar must rotate 90 degrees if user would become the vertical connection.



**TAB-3200 Fixed-type**

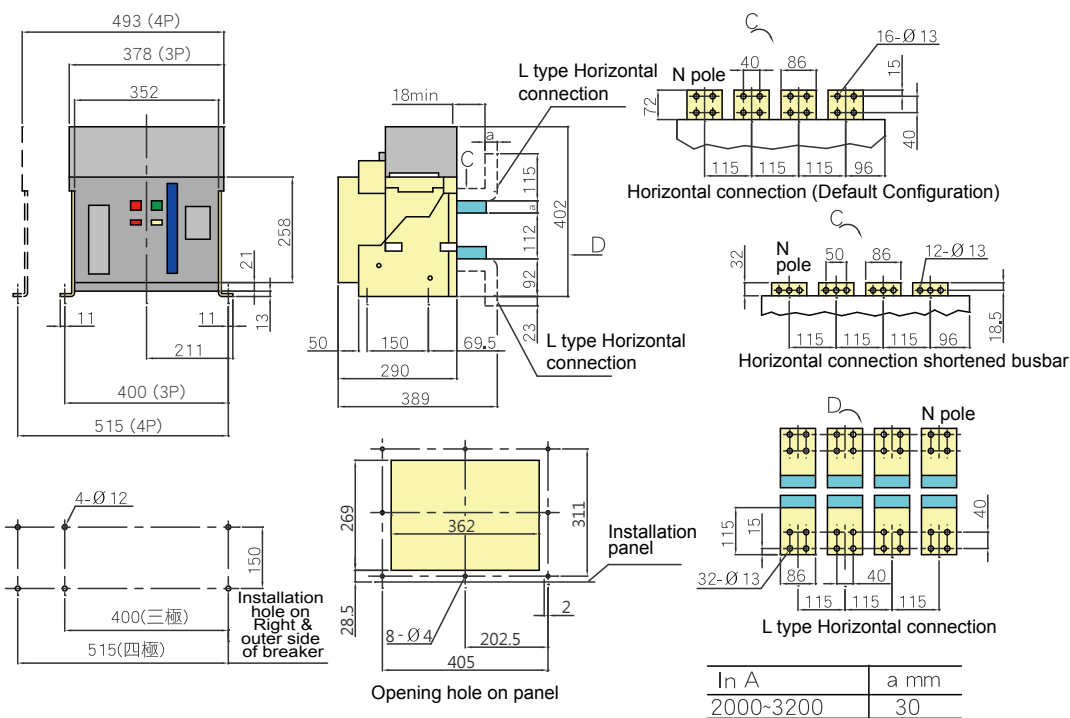

**TAB-3200 Drawout-type**

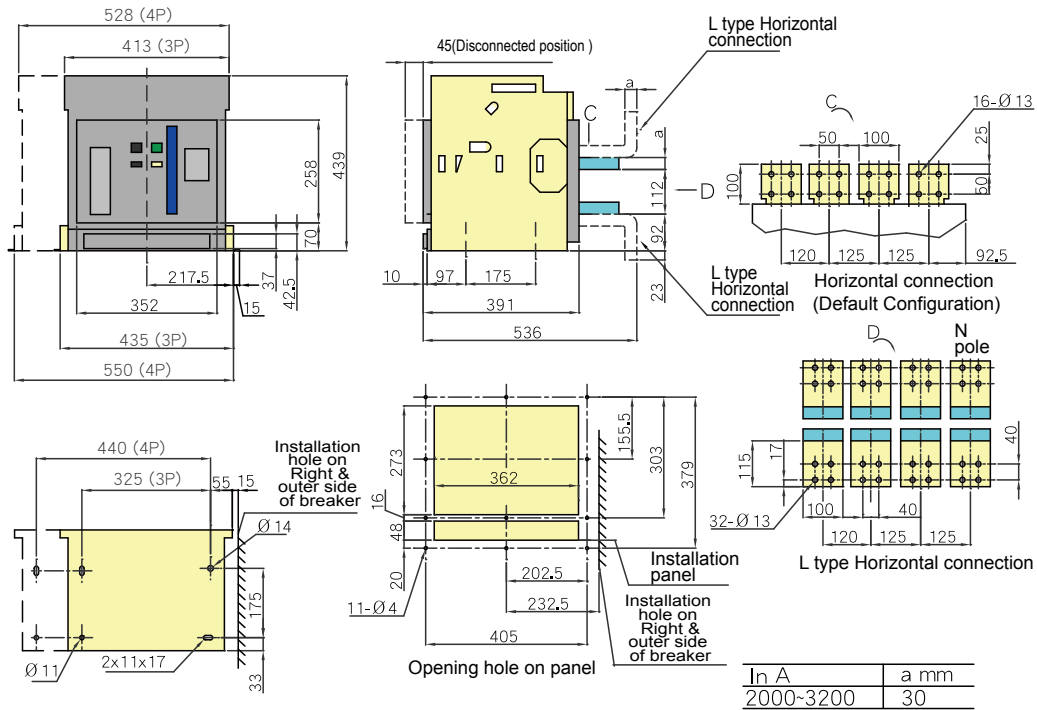

**TAB-3200 Drawout-type, Horizontal, rear connection**

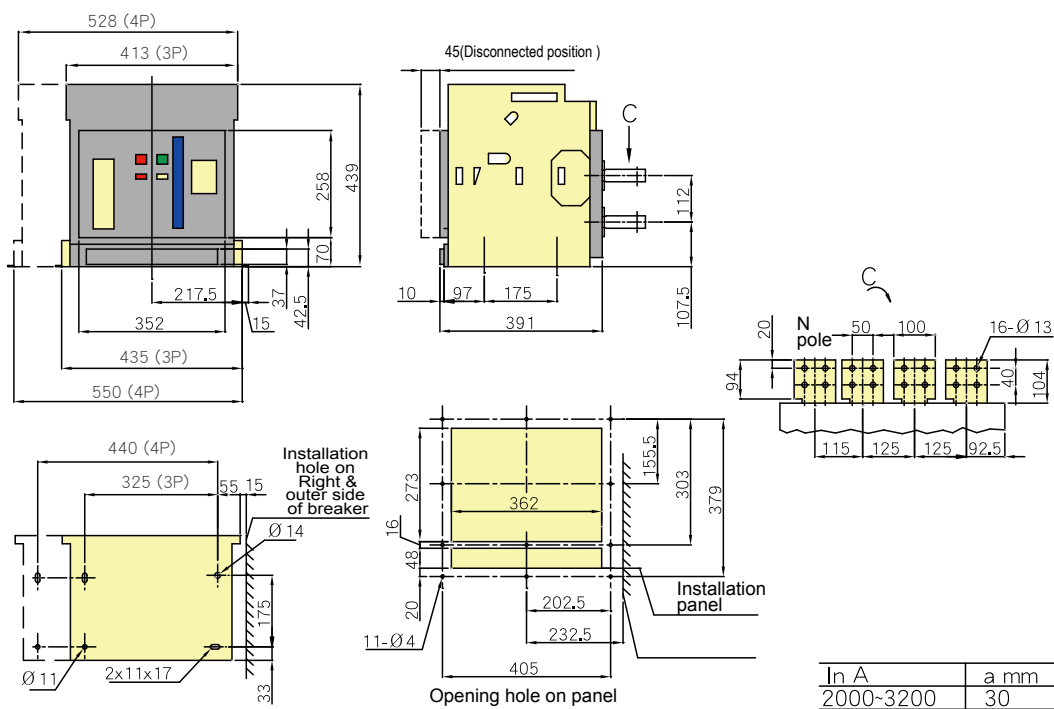

Note : The busbar must rotate 90 degrees if user would become the vertical connection.

**TAB-3200 Drawout-type, Vertical, rear connection**

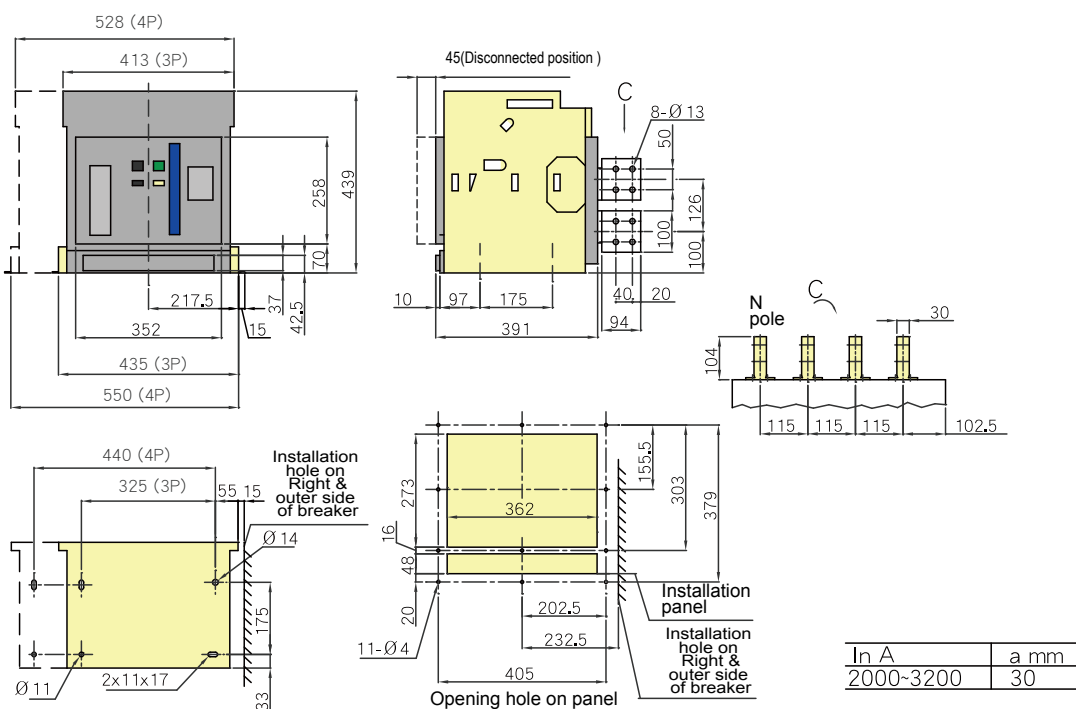

Note : The busbar must rotate 90 degrees if user would become the vertical connection.

**TAB-5000 Fixed-type**

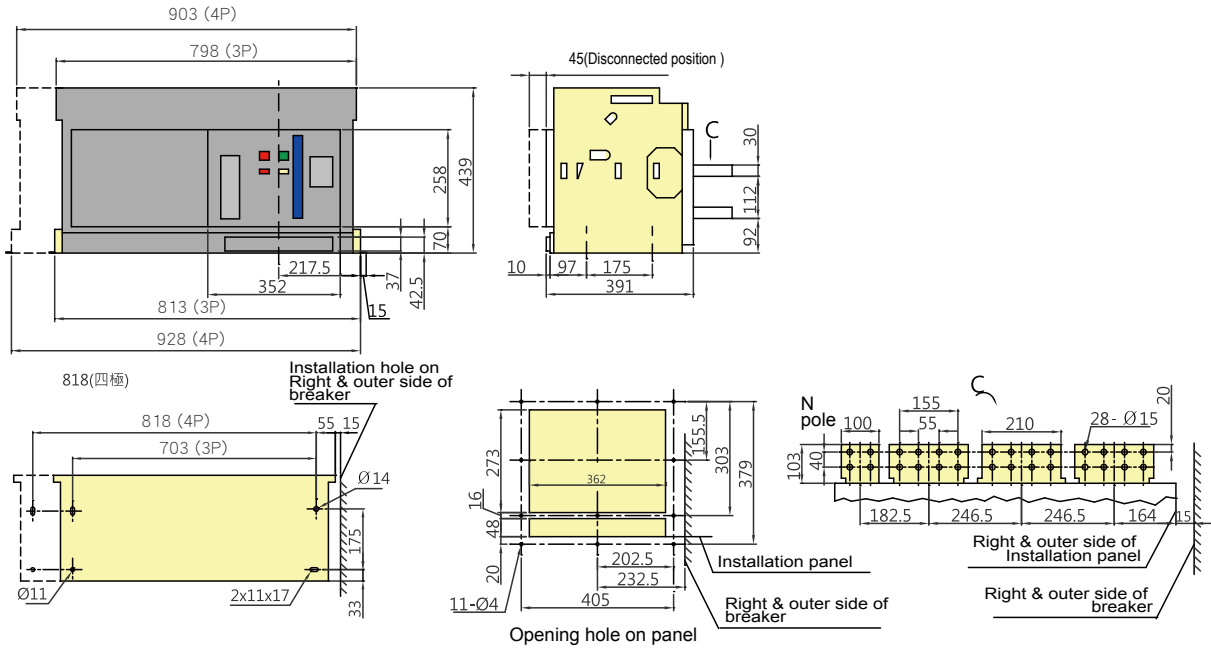

## Secondary circuit wiring

- TAB-2000N/3200 Secondary circuit wiring diagram for the circuit breaker equipped with M/3M type digital trip relay, undervoltage instantaneous release :
- TAB-5000 Secondary circuit wiring diagram for the circuit breaker equipped with M/3M type digital trip relay and undervoltage (instantaneous / time-delay) release :

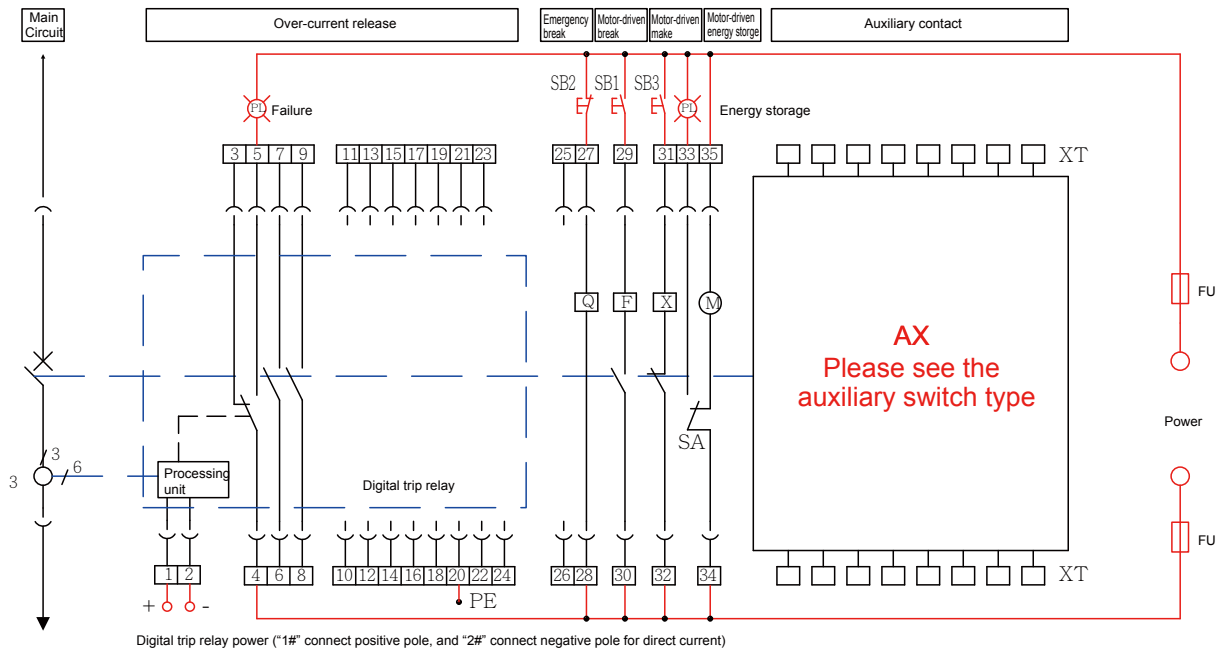

※ Standard configuration for drawout-type: The secondary connecting part of 47 poles .

※ Standard configuration for fixed-type: The secondary connecting part of 51 poles .

### The auxiliary switch type :

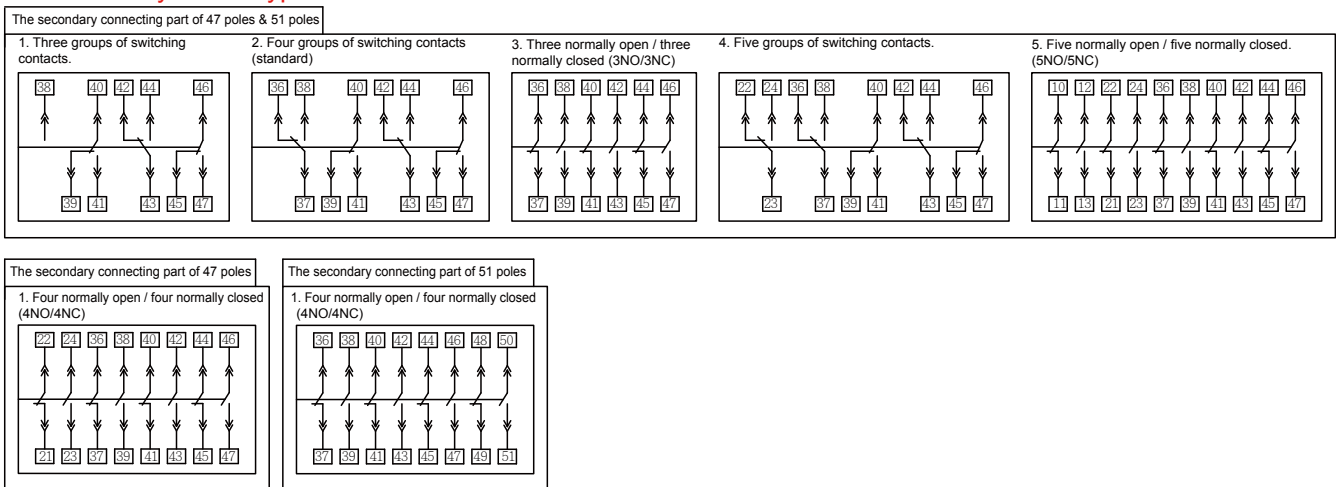

**SB1** : Opening pushbutton ; **SB2** : Emergency opening pushbutton ; **SB3** : Closing button ;

**Q** : Under-voltage release ; **F** : Shunt release ; **X** : Closing electromagnet ; **M** : Energy storage motor ;

**XT** : Terminal ; **SA** : Travel switch ; **FU** : Fuse 6A ; **PL** : Indicating lamp ;

**1#**, **2#** : Digital trip relay power input (Note: When the digital trip relay power is AC power, **1#**, **2#** terminals directly input AC power; **1#** connect positive pole, and **2#** connect negative pole for direct current.)

**3#**, **4#**, **5#** : Fault trip contact output (**4#** common terminal)

**6#**, **7#**, **8#**, **9#** : Auxiliary contact, normal open

**10#~24#** : empty

**25#**, **26#** : to be connected with current transformer of N pole (optional)

**27#**, **28#** : Under-voltage release (optional)

**29#**, **30#** : Shunt release

**31#**, **32#** : Closing release

**33#**, **34#** : Energy storage indicator

**34#**, **35#** : Energy storage motor

**36#~51#** : Auxiliary contact

Note : 1. Red colored part is to be connected by users.

2. Terminals **6#**, **7#** can output NC(normal close) contact if that is required by users.

3. Terminal **35#** can be directly connected to power (automatic pre-storing energy), alternatively connect power after connecting NO button (manual-controlled pre-storing energy.)

4. When the emergency opening pushbutton is used to disconnect the circuit breaker, attention should be paid that if the undervoltage release has the delay function, after pressing the emergency opening pushbutton, the circuit breaker can be switched off after passing through the setting time of undervoltage delay.

◆ TAB-2000N/3200 Secondary circuit wiring diagram for the circuit breaker equipped with M/3M type digital trip relay and under-voltage time-delay release :

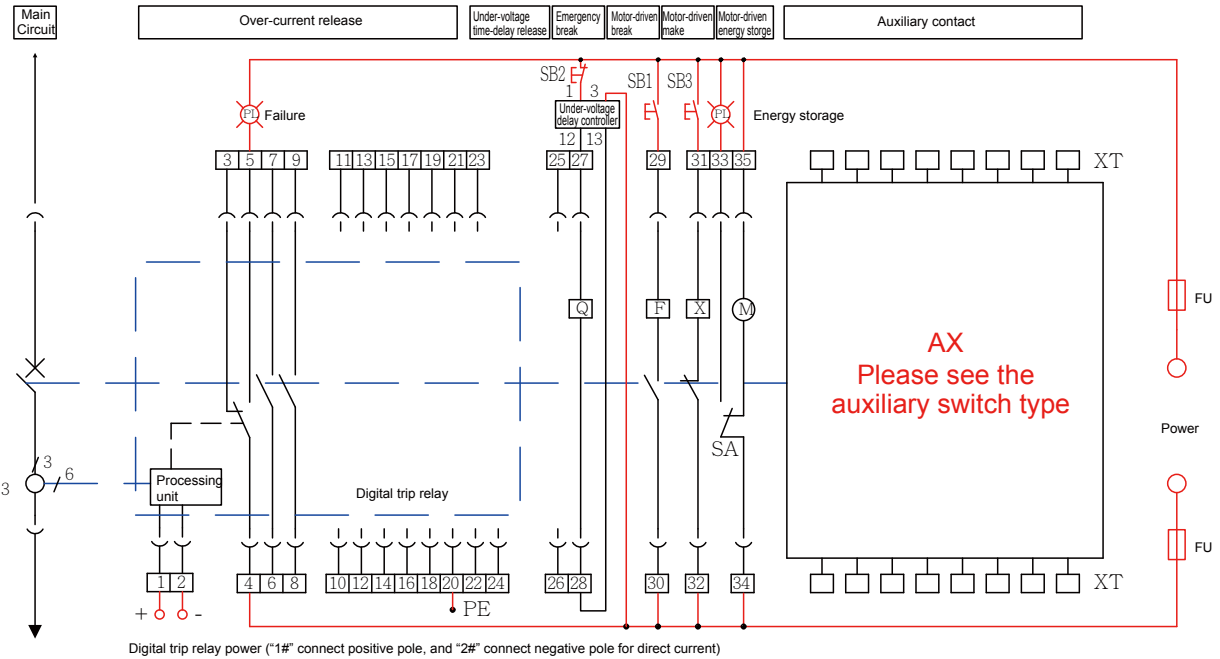

※ Standard configuration for drawout-type: The secondary connecting part of 47 poles .

※ Standard configuration for fixed-type: The secondary connecting part of 51 poles .

The auxiliary switch type :

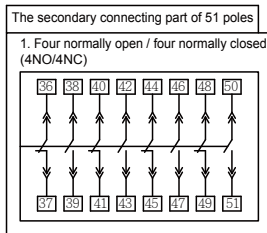
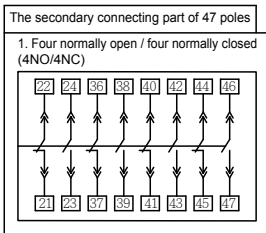
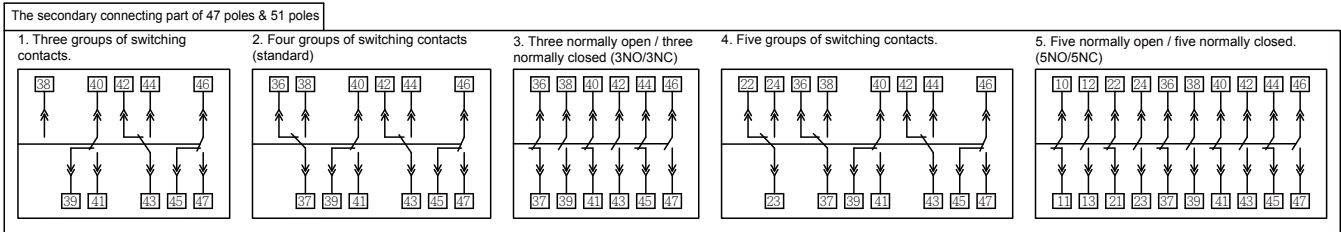

- SB1** : Opening pushbutton ; **SB2** : Emergency opening pushbutton ; **SB3** : Closing button ;
- Q** : Under-voltage time-delay release ; **F** : Shunt release ; **X** : Closing electromagnet ; **M** : Energy storage motor ;
- XT** : Connection terminal ; **SA** : Travel switch ; **FU** : Fuse 6A ; **PL** : Indicating lamp ;
- 1#**, **2#** : Digital trip relay power input (Note: When the digital trip relay power is AC power, **1#**, **2#** terminals directly input AC power; **1#** connect positive pole, and **2#** connect negative pole for direct current.
- 3#**, **4#**, **5#** : Fault trip contact output (**4#** common terminal)
- 6#**, **7#**, **8#**, **9#** : Auxiliary contact, normal open
- 10#~24#** : empty
- 25#**, **26#** : to be connected with current transformer of N pole (optional)
- 27#**, **28#** : Under-voltage release (optional)
- 29#**, **30#** : Shunt release
- 31#**, **32#** : Closing release
- 33#**, **34#** : Energy storage indicator
- 34#**, **35#** : Energy storage motor
- 36#~51#** : Auxiliary contact

Note : 1. Red colored part is to be connected by users.

2. Terminals **6#**, **7#** can output NC(normal close) contact if that is required by users.

3. Terminal **35#** can be directly connected to power (automatic pre-storing energy), alternatively connect power after connecting NO button (manual-controlled pre-storing energy.)

4. When the emergency opening pushbutton is used to disconnect the circuit breaker, attention should be paid that if the undervoltage release has the delay function, after pressing the emergency opening pushbutton, the circuit breaker can be switched off after passing through the setting time of undervoltage delay.

5. The undervoltage delay controller connects with an undervoltage release only.

# Purchase Sheet



TAB-2000N~5000 Ordering specification

Customer :

Tel :

Quantity :

Date :

Model	Rated current In(A)	Number of poles	Installation mode	The main circuit connection	
				Standard ( <input checked="" type="checkbox"/> : default)	Special requirement (additional order)
<input type="checkbox"/> TAB-2000N (Frame I)	<input type="checkbox"/> 630 <input type="checkbox"/> 800 <input type="checkbox"/> 1000 <input type="checkbox"/> 1250 <input type="checkbox"/> 1600 <input type="checkbox"/> 2000	<input type="checkbox"/> 3P <input type="checkbox"/> 4P	<input type="checkbox"/> Fixed type	<input checked="" type="checkbox"/> Horizontal connection	<input type="checkbox"/> Vertical connection (with L vertical bus-bar) <input type="checkbox"/> Rotation busbar horizontal connection (drawout-type In≤3200) <input type="checkbox"/> Rotation busbar vertical connection (drawout-type In≤3200) Module : <input type="checkbox"/> Position signaling devices ( <input type="checkbox"/> Connected <input type="checkbox"/> Test <input type="checkbox"/> Unconnected)
<input type="checkbox"/> TAB-3200 (Frame II)	<input type="checkbox"/> 2000 <input type="checkbox"/> 2500 <input type="checkbox"/> 3200		<input type="checkbox"/> Drawout type		<input checked="" type="checkbox"/> Horizontal connection
<input type="checkbox"/> TAB-5000 (Frame III)	<input type="checkbox"/> 4000 <input type="checkbox"/> 5000		<input checked="" type="checkbox"/> Drawout type		
<b>Digital trip relay controller classification (Optional)</b>					
Intelligent Controller	Type	Protection function ( <input checked="" type="checkbox"/> :Conventional factory setting. Check at the other option if you need.)		Increasing annex function (additional order)	
	<input type="checkbox"/> M type (Standard)	<input checked="" type="checkbox"/> Ir overload long delay, Isd short-circuit short delay inverse time + definite time, li transient short-circuit, lg single-phase grounding 4-section protection. <input type="checkbox"/> Ir overload long delay, Isd definite time short-circuit short delay, li transient short-circuit, lg single-phase grounding 4-section protection.		<input type="checkbox"/> External current transformer earthing protection (3P + N model)	
	Frequency <input type="checkbox"/> 50Hz <input checked="" type="checkbox"/> 60Hz				
	<input type="checkbox"/> 3M type (Multifunctional)	<input checked="" type="checkbox"/> Ir overload long delay, Isd short-circuit short delay inverse time + definite time, li transient short-circuit, lg single-phase grounding 4-section protection. <input type="checkbox"/> Ir overload long delay, Isd definite time short-circuit short delay, li transient short-circuit, lg single-phase grounding 4-section protection.		<input type="checkbox"/> No additional function <input type="checkbox"/> S1 function <input type="checkbox"/> S2 function <input type="checkbox"/> S3 function <input type="checkbox"/> ZSI + S2 function <input type="checkbox"/> ZSI + S3 function <input type="checkbox"/> Earthing protection + NCT(3P+N)(external current transformer) [No 3P+N:TAB-5000] <input type="checkbox"/> Earth leakage protection + ZT100 (external current transformer) <input type="checkbox"/> Earth leakage protection + ZCT1 (external current transformer) (The functions of type of 3M, please see the "3M/H type digital trip relay Instruction Manual".)	
	<input type="checkbox"/> H type (communication)	<input checked="" type="checkbox"/> Ir overload long delay, Isd short-circuit short delay inverse time + definite time, li transient short-circuit, lg single-phase grounding 4-section protection. <input type="checkbox"/> Ir overload long delay, Isd definite time short-circuit short delay, li transient short-circuit, lg single-phase grounding 4-section protection. <input checked="" type="checkbox"/> MODBUS communication protocol(Built-in)		<input type="checkbox"/> No additional function <input type="checkbox"/> S1 function <input type="checkbox"/> S2 function <input type="checkbox"/> S3 function <input type="checkbox"/> ZSI + S2 function <input type="checkbox"/> ZSI + S3 function <input type="checkbox"/> Earthing protection + NCT(3P+N)(external current transformer) [No 3P+N:TAB-5000] <input type="checkbox"/> Earth leakage protection + ZT100 (external current transformer) <input type="checkbox"/> Earth leakage protection + ZCT1 (external current transformer) <input type="checkbox"/> PROFIBUS-DP communication protocol (Optional) (The functions of type of H, please see the "3M/H type digital trip relay Instruction Manual".)	
Digital trip relay power	<input type="checkbox"/> AC110V <input checked="" type="checkbox"/> AC220V <input type="checkbox"/> AC380V <input type="checkbox"/> DC110V* <input type="checkbox"/> DC220V*		(The factory default is AC220V. Check at the other option if you need.)		
Electrical accessories	Shunt release	<input type="checkbox"/> AC110V <input checked="" type="checkbox"/> AC220V <input type="checkbox"/> AC380V <input type="checkbox"/> DC110V		(The factory default is AC220V. Check at the other option if you need.)	
	Closing electromagnet	<input type="checkbox"/> AC110V <input checked="" type="checkbox"/> AC220V <input type="checkbox"/> AC380V <input type="checkbox"/> DC110V			
	Electric motor	<input type="checkbox"/> AC110V <input checked="" type="checkbox"/> AC220V <input type="checkbox"/> AC380V <input type="checkbox"/> DC110V			
Auxiliary contact	<input type="checkbox"/> 3NO/3NC <input type="checkbox"/> 4NO/4NC <input type="checkbox"/> 5NO/5NC(M type) <input type="checkbox"/> Five groups of switching contacts <input checked="" type="checkbox"/> Four groups of switching contacts <input type="checkbox"/> Three groups of switching contacts (The factory default is four switch contact. The auxiliary contact modes for customer use, please see the instruction in "Secondary circuit wiring".)				
Special requirements (additional order)	Under voltage release (UVT)	Power voltage : <input type="checkbox"/> DC24V <input type="checkbox"/> AC110V <input type="checkbox"/> AC220V <input type="checkbox"/> AC380V <input type="checkbox"/> DC110V <input type="checkbox"/> DC220V (Only AC power can be used for delay type.) Action types : <input type="checkbox"/> Instantaneous <input type="checkbox"/> Delay (Resistance capacity loss release delay) : <input type="checkbox"/> 1s <input type="checkbox"/> 3s <input type="checkbox"/> 5s, and optional non-adjustable			
	Interlock device	Mechanical linkage : <input type="checkbox"/> Link interlock <input type="checkbox"/> Cable interlock Door interlock : <input type="checkbox"/> Switch body position door interlock (drawout-type) <input type="checkbox"/> Switch on/off state door interlock Button lock : <input type="checkbox"/> Panel products on/off button lock key lock : <input type="checkbox"/> 1 lock 1 key <input type="checkbox"/> 2 locks 1 key <input type="checkbox"/> 3 locks 1 key <input type="checkbox"/> 3 locks 2 keys <input type="checkbox"/> Special custom__lock__key (Optional)			
	Other accessories	<input type="checkbox"/> Cover <input type="checkbox"/> Transparent shield(only for TAB- 2000N) <input type="checkbox"/> The secondary connecting part shield(drawout-type) <input type="checkbox"/> The secondary connecting part shield + special the secondary connecting part(fixed-type) <input type="checkbox"/> Mechanical counter (digital trip relay had a counter function already)			
Protection characteristic of digital trip relay	Protection function settable range and conventional factory tuning	Ir long delay current setting range : (0.4~1)In		Conventional factory tuning : overload delay 1.0In	
		Overload 1.5Ir action time setting range : 15, 30, 60.....480s		Conventional factory tuning : overload 1.5In : action 15s	
		Isd short delay current setting range : (1.5~15)Ir		Conventional factory tuning : short delay current 8IR	
		Short delay action time : (0.1~0.4)s		Conventional factory tuning : short delay action time 0.4s	
li instantaneous current setting range : (1.5~20)In / 50kA / 65kA / 75kA		Conventional factory tuning : 12In			
lg earthing protection current setting range : (0.2~0.8)In		Conventional factory tuning : 0.5In			
the earthing protection time setting range : (0.1~0.4)s		Conventional factory tuning : OFF			

Remark: The casing current, rated current and auxiliary control voltage must be specified when ordering.

Note 1. Please mark "✓" or fill figure in the relative "□" if no mark, we will provide according to conventional.

2. The operational function of the digital trip relay and special requirements require additional costs.

3. If external current transformer used on 3 poles product, please state external current transformer (3P+N) when ordering.

4. Assemble fixed-plate before put on phases barrier for fixed-type product, but not for draw out-type product.

5. The digital trip relay with the DC 110V/220V can connect terminal 1# and 2# of the secondary connecting part only if the power supply module is changed to the dc24V.





**TECO ELECTRIC & MACHINERY CO., LTD.**

10F, No. 3-1, Yuan Cyu St., Nan-Kang District, Taipei 115, Taiwan

TEL : 886-2-6619-9111Ext.2510

FAX : 886-2-6615-2033

<http://www.teco.com.tw/sa/en>

Distributor

GC—26-01 2020-08-08